

## User Manual Easy UPS On-Line SRV5KRI, SRV6KRI, SRV10KRI, SRV6KI and SRV10KI

### Important Safety Instructions

SAVE THESE INSTRUCTIONS - This manual contains important instructions that should be followed during installation and maintenance of the UPS and batteries.



Read these instructions carefully and look at the equipment to become familiar with the device before trying to install, operate, service or maintain it.

The following special messages may appear throughout this manual or on the equipment to warn of potential hazards or to call attention to information that clarifies or simplifies a procedure.



The addition of this symbol either to a “Danger” or “Warning” safety label indicates that an electrical hazard exists which will result in personal injury if the instructions are not followed.



This is the safety alert symbol. It is used to alert you to potential personal injury hazards. Obey all safety messages that follow this symbol to avoid possible injury or death.



### **DANGER**

**DANGER** indicates a hazardous situation which, if not avoided, **will result in death or serious injury**.



### **WARNING**

**WARNING** indicates a hazardous situation which, if not avoided, **could result in death or serious injury**.



### **CAUTION**

**CAUTION** indicates a hazardous situation which, if not avoided, **could result in minor or moderate injury**.

### **NOTICE**

**NOTICE** is used to address practices not related to physical injury.

# Product Handling Guidelines

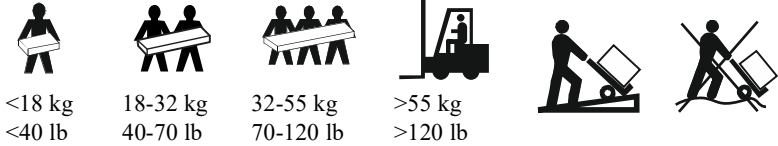

## Safety and General Information

Inspect the package contents upon receipt. Notify the carrier and dealer if there is any damage.

Read the Safety Guide before installing the UPS.

- This UPS is for indoor use only.
- Do not operate the UPS in direct sunlight, in contact with fluids, or where there is excessive dust or high humidity.
- Do not operate the UPS near open windows or doors.
- Be sure the air vents on the UPS are not blocked. Allow adequate space for proper ventilation.

**NOTE:** Allow a minimum of 20 cm clearance on both front and rear sides of the UPS.

- Environmental factors impact battery life. Elevated ambient temperatures and poor quality utility power causing frequent discharges will shorten battery life. Follow the battery manufacturer recommendations.

### Electrical safety

#### **WARNING**

##### **RISK OF ELECTRIC SHOCK**

The output terminals of the UPS are energized as the utility circuit breaker is on and the input voltage is applied to input terminals. Be sure to turn off the utility circuit breaker to de-energize the output terminals.

**Failure to follow these instructions can result in death or serious injury.**

- When grounding cannot be verified, disconnect the equipment from the utility power outlet before installing or connecting to other equipment. Reconnect the power cord only after all connections are made.
- Connection to the branch circuit (mains) must be performed by a qualified electrician.
- The protective earth conductor for the UPS carries the leakage current from the load devices (computer equipment). An insulated ground conductor is to be installed as part of the branch circuit that supplies input power to the UPS. The conductor must have the same size and insulation material as the grounded and ungrounded branch circuit supply conductors. The conductor will be green and with or without a yellow stripe.

- The grounding conductor is to be grounded to earth at the service equipment, or if supplied by a separately derived system, at the supply transformer or motor generator set.

## Battery safety



## CAUTION

### RISK OF HYDROGEN SULPHIDE GAS AND EXCESSIVE SMOKE

- Replace the battery at least every 5 years or the battery is at the end of its service life, whichever is earlier.
- Replace the battery immediately when the UPS indicates battery replacement is necessary.
- Replace batteries with the same number and type of batteries as originally installed in the equipment.
- Replace the battery immediately when the UPS indicates a battery over-temperature condition, or when there is evidence of electrolyte leakage. Power off the UPS, unplug it from the AC input, and disconnect the batteries. Do not operate the UPS until the batteries have been replaced.
- \*Replace all battery modules (including the modules in External Battery Packs) which are older than one year, when installing additional battery packs or replacing the battery module(s).

**Failure to follow these instructions can result in injury.**

\* Contact APC by Schneider Electric Worldwide Customer Support to determine the age of the installed battery modules.

For the recycling battery information, please go to [apc.com/recycle](http://apc.com/recycle).

- Servicing of user replaceable batteries should be performed or supervised by personnel knowledgeable about batteries and required precautions. In this case, batteries is not user replaceable.
- APC by Schneider Electric uses Sealed Maintenance Free Valve Regulated Lead Acid battery. Under normal use and handling, there is no contact with the internal components of the batteries. Over charging, over heating or other misuse of batteries can result in leakage of battery electrolyte.
- CAUTION: Do not dispose of batteries in a fire. The batteries may explode.
- CAUTION: Do not open or mutilate the battery or batteries. Released material is harmful to the skin and eyes. It may be toxic.
- CAUTION: Failed batteries can reach temperatures that exceed the burn thresholds for touchable surfaces.
- Before replacing batteries, remove conductive jewelry such as chains, wrist watches, and rings. High energy through conductive materials could cause severe burns.

- **CAUTION:** A battery can present a risk of electric shock and burns by high short-circuit current. The following precautions should be observed when working on batteries:
  - Disconnect the charging source prior to connecting or disconnecting battery terminals.
  - Do not wear any metal objects including watches and rings.
  - Do not lay tools or metal parts on top of batteries.
  - Use tool with insulated handles.
  - Wear rubber gloves and boots.
  - Determine if battery is either intentionally or inadvertently grounded. Contact with any part of a grounded battery can result in electric shock or burns by high short-circuit current. The risk of such hazards can be reduced if grounds are removed during installation and maintenance by a skilled person.

### **Hardwiring safety**

- Verify that all branch circuit (mains) and low voltage (control) circuits are de-energized, and locked out before installing cables or making connections, whether in the junction box or to the UPS.
- Wiring by a qualified electrician is required.
- Check national and local codes before wiring.
- Select wire size and connectors according to national and local codes.
- All openings allowing access to UPS hardwiring terminals must be covered. Failure to do so may result in personal injury or equipment damage.

## **Radio Frequency Warning**

This UPS is a category C3 product as per IEC 62040-2, meant for commercial and industrial application in the second environment - installation restrictions or additional measures may be needed to prevent disturbances.

**NOTE:** To maintain compliance with the EMC directive for products, output cords and network cables connected to the UPS should not exceed 10 meters in length.

## **Product Description**

The APC by Schneider Electric Easy UPS is a high performance, uninterruptible power supply (UPS). The UPS helps to provide protection to electronic equipment from utility power blackouts, brownouts, sags, surges, small utility fluctuations and large disturbances. The UPS also provides battery backup power to connected equipment until utility power returns to normal levels or the batteries are fully discharged.





This user manual is available on the enclosed Documentation CD and on the APC by Schneider Electric Web site, [www.apc.com](http://www.apc.com).

# Package Contents

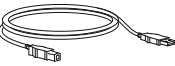

Read the Safety Guide before installing the UPS.

The packaging is recyclable; save it for reuse or dispose it off properly.

## Common to all models

<p>User documentation</p> 	<p>Software, User documentation CD</p> 	<p>USB cable</p> 
		<p>RS-232 cable</p> 

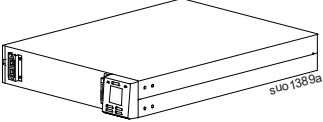
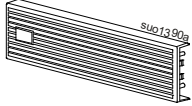
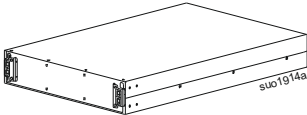
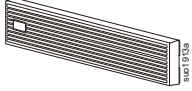
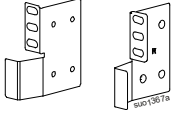
## For SRV5KRI, SRV6KRI and SRV10KRI

<p>UPS</p> 	<p>Battery pack front bezel</p> 
<p>Battery pack</p> 	<p>Battery pack front bezel</p> 
<p>Rack-mount bracket 2 pairs (1 pair each for UPS and battery pack)</p> 	<p>Battery cable</p>  <p>Flat head screws 16x (8x for UPS and 8x for battery pack)</p> 

## For SRV6KI and SRV10KI

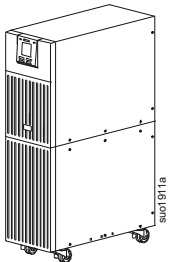
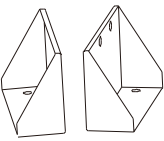
<p>UPS</p> 	<p>Locking bracket (1 pair)</p> 
--	---

## Optional Accessories

Refer to the APC by Schneider Electric Web site, [www.apc.com](http://www.apc.com), for available accessories.

# Specifications

## Environmental

### NOTICE

#### RISK OF EQUIPMENT DAMAGE

- The UPS must be used indoors only.
- The installation location should be sturdy to withstand the weight of the UPS.
- Do not operate UPS where there is excessive dust or where the temperature or humidity are outside specified limits.

**Failure to follow these instructions can result in equipment damage.**

		SRV5KRI	SRV6KRI SRV6KI	SRV10KRI SRV10KI
Temperature	Operating	<ul style="list-style-type: none"> <li>• 0 to 40 °C at rated load</li> <li>• 40 to 45 °C linearly derated to 85% of maximum load capacity</li> <li>• 45 to 50 °C linearly derated to 75% of maximum load capacity</li> </ul>		
	Storage	-15 to 60 °C		
Elevation	Operating	<ul style="list-style-type: none"> <li>• 0 to 1,000 m: Normal operation</li> <li>• 1,000 to 3,000 m: The output power reduces @ 1% for every 100 m increase in elevation</li> <li>• &gt; 3,000 m: UPS will not work</li> </ul>		
	Storage	0 to 15,000 m		
Humidity		0 to 95% relative humidity, non-condensing		
International Protection Code		IP20		
Pollution Degree		2		

**NOTE:** Charge the battery module at least once in every six months during storage.

## Physical

The equipment is heavy. Follow all lifting guidelines.

UPS		SRV5KRI	SRV6KRI	SRV10KRI
Power Module		SRVPM5KRI	SRVPM6KRI	SRVPM10KRI
Battery Pack		SRV192RBP-7A		SRV192RBP-9A
Dimensions with package Height x Width x Depth	Power Module	240 x 600 x 760 mm (9.45 x 23.62 x 29.92 in)		
	Battery Pack	245 x 565 x 836 mm (9.64 x 22.24 x 32.91 in)		
Dimensions without package Height x Width x Depth	Power Module	86.5 x 438 x 615 mm (3.41 x 17.2 x 24.21 in) *D1=580 mm (22.83 in); *D2=638 mm (25.19 in)		
	Battery Pack	86.5 x 438 x 710 mm (3.41 x 17.2 x 27.95 in)		

UPS		SRV5KRI	SRV6KRI	SRV10KRI
Weight with package (approx.)	Power Module	18 kg		20 kg
	Battery Pack	53 kg		59 kg
Weight without package (approx.)	Power Module	14 kg		16 kg
	Battery Pack	47 kg		53 kg

\* Details of D1 and D2

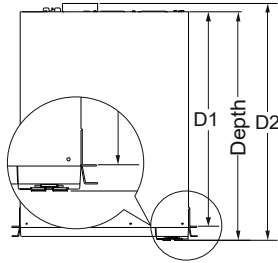

	SRV6KI	SRV10KI
Dimensions with package Height x Width x Depth	910 x 290 x 495 mm (35.83 x 11.42 x 19.49 in)	910 x 290 x 580 mm (35.83 x 11.42 x 22.83 in)
Dimensions without package Height x Width x Depth	685 x 190 x 374 mm (26.97 x 7.48 x 14.72 in) * D2 = 406 mm (15.98 in)	685 x 190 x 447 mm (26.97 x 7.48 x 17.60 in) * D2 = 479 mm (18.86 in)
Weight with package (approx.)	66 kg	77 kg
Weight without package (approx.)	54 kg	65 kg

\* Details of D2

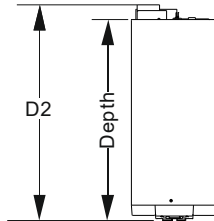

## Electrical

<b>Over voltage Category</b>	II
<b>Applicable Power Grid Power Distribution System</b>	TN Power System
<b>Applicable Standard</b>	IEC 62040-1

## Input

<b>Nominal input voltage</b>	230 VAC
<b>Nominal input frequency</b>	50/60 Hz nominal
<b>Input voltage range (100% load)</b>	176 to 300 VAC $\pm 3\%$
<b>Input voltage range (60% load)</b>	110 to 300 VAC $\pm 3\%$
<b>Input power factor (100% resistive load at nominal voltage)</b>	$\geq 0.99$ at 100% load
<b>Input over current protection</b>	Thermal Circuit breaker

## Output

	SRV5KRI	SRV6KRI SRV6KI	SRV10KRI SRV10KI
<b>Capacity</b>	5 kVA / 5 kW	6 kVA / 6 kW	10 kVA / 10 kW
<b>Nominal output voltage</b>	230 VAC		
<b>Other programmable voltage</b>	220 VAC, 240 VAC		
<b>Efficiency at rated load</b>	$> 94\%$		
<b>Output voltage regulation</b>	$\pm 1\%$ static		
<b>Output voltage distortion</b>	<ul style="list-style-type: none"> <li>• 1% max. for full linear load</li> <li>• 4% max. for full RCD load (100% VA, 0.8 PF)</li> <li>• 15% for the last 60 seconds of the backup time (with full load only for the internal battery)</li> </ul>		
<b>Frequency - On battery</b>	50/60 Hz $\pm 0.1$ Hz		
<b>Frequency - AC mode (auto-sensing)</b>	50/60 Hz $\pm 4$ Hz		
<b>Crest factor</b>	3:1		
<b>Waveform</b>	Sinewave		
<b>Output connection</b>	Terminal		
<b>Bypass</b>	Internal		
<b>Bypass range</b>	185 to 250 VAC $\pm 1\%$		

## Battery

UPS	SRV5KRI	SRV6KRI	SRV10KRI	SRV6KI	SRV10KI
<b>Battery pack</b>	SRV192RBP-7A		SRV192RBP-9A	—	—
<b>Configuration</b>	External Battery			Internal Battery	
<b>Type</b>	Sealed maintenance free valve regulated lead acid battery				
<b>Rating</b>	12 V, 7 Ah		12 V, 9 Ah	12 V, 7 Ah	12 V, 9 Ah
<b>Voltage</b>	192 V				



# Rear Panel Features

SRV5KRI/SRV6KRI/SRV10KRI

UPS

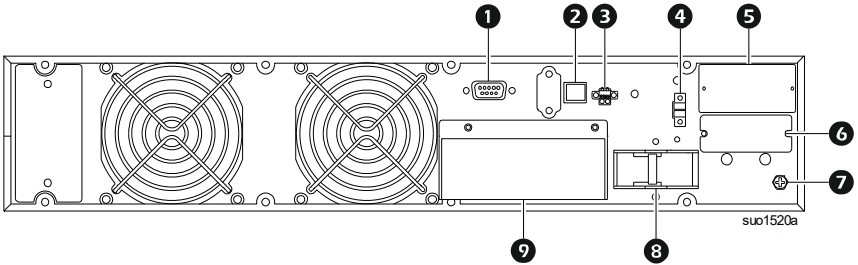

1	Serial communication (RS-232) port	6	Battery connector
2	USB port	7	Ground screw
3	Emergency power off (EPO) connector	8	Input circuit breaker
4	External maintenance bypass signal port	9	Input and output hardwiring terminals Refer "Hardwiring" on page 14 for details.
5	Intelligent card slot		

## Battery Pack

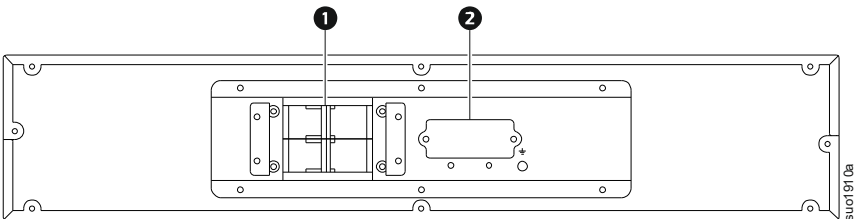

1	Battery circuit breaker
2	Battery connector

## SRV6KI/SRV10KI

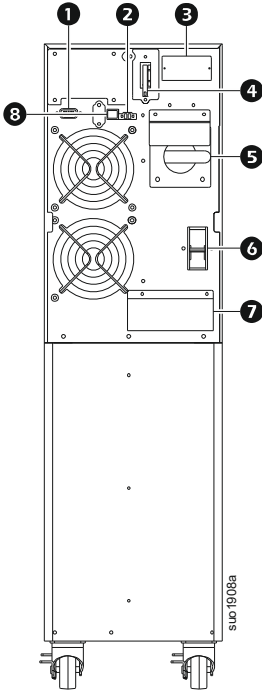

<b>1</b>	Serial communication (RS-232) port
<b>2</b>	Emergency Power Off (EPO) terminals
<b>3</b>	Intelligence card slot
<b>4</b>	Battery disconnecter
<b>5</b>	Maintenance Bypass switch
<b>6</b>	Input circuit breaker
<b>7</b>	Input and output hardwiring terminals Refer “Hardwiring” on page 14 for details.
<b>8</b>	USB port

## Basic Connectors

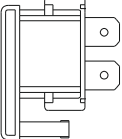
 <p><b>USB</b>    <b>Serial Port</b>    <b>Intelligent slot card</b></p>	<p>Power management software and interface kits can be used with the UPS.  <b>NOTE:</b> Be sure to only use the supplied interface kits or those approved by APC by Schneider Electric.</p>
<p><b>Battery disconnecter</b>          (Applicable only for SRV6KI and SRV10KI).</p> 	<p>SRV6KI and SRV10KI are equipped with internal battery.          While shipping out these models from the factory, the internal battery is disconnected.          Refer to “Connect Battery” on page 17 for details.</p>

# Rack-Mount Installation

**NOTE:** Applicable only for SRV5KRI/SRV6KRI/SRV10KRI models.

## CAUTION

### RISK OF FALLING EQUIPMENT

- The UPS is heavy. Always practice safe lifting techniques adequate for the weight of the equipment.
- Do not lift the UPS by holding the front panel display.
- Always install the UPS at the bottom of the rack.
- Given the heavy weight, the use of rack-mount brackets is mandatory during rack installation (guide with L-shaped support).
- Always use the recommended number of screws to secure brackets to the UPS.
- Install the UPS above the Battery pack.
- Secure the unit in the rack using all the screws supplied for the purpose.

**Failure to follow these instructions can result in minor or moderate injury and equipment damage.**

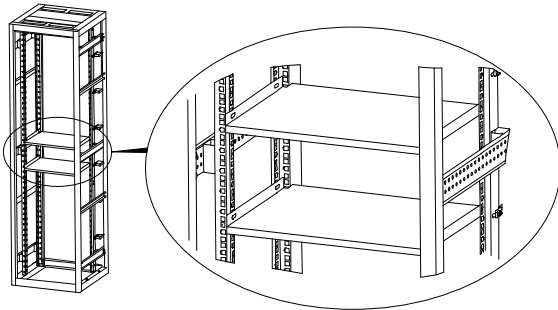

- Before installing the UPS and the battery pack in the 19 inch rack, be sure that a shelf is fitted in the rack and the shelf is capable of withstanding the weight of the UPS and the battery pack.
- Alternatively, optional Rail Kit accessories SRVRK1 to enable the installation of the UPS in rack-mount configuration and SRVRK2 to enable the installation of the Battery pack, are separately available for purchase.

**NOTE:** Install the Battery pack below the UPS.

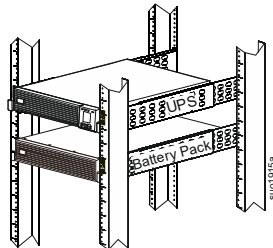

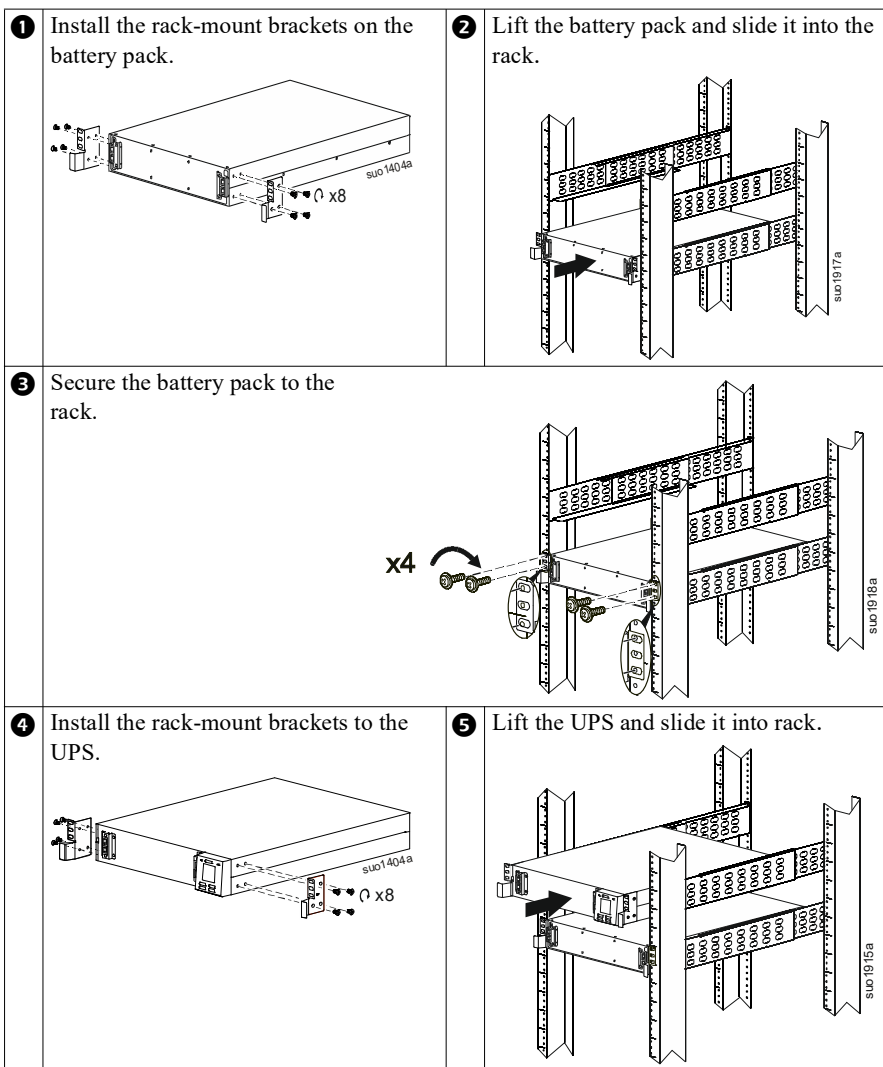

6 Secure the UPS module to the rack.

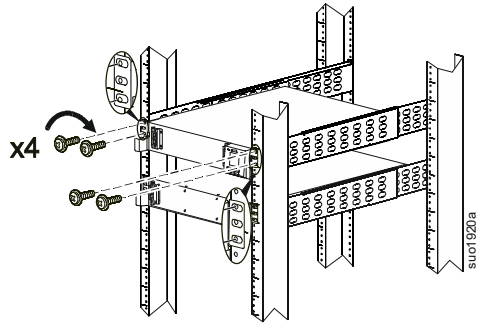

4 Install the front bezel for both the battery pack as well as the UPS.

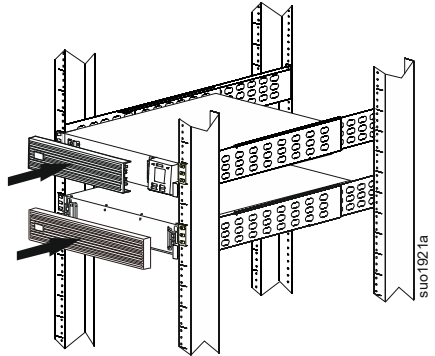

# Hardwiring

## CAUTION

### RISK OF ELECTRIC SHOCK

- Adhere to all national and local electrical codes.
- All electrical work must be performed by a qualified electrician.
- Turn off all power to this equipment before working on the equipment.
- Switch the external circuit breaker off. Practice lockout/tagout procedures.
- Do not wear jewelry when working with electrical equipment.
- Select wire size and connectors according to national and local codes.

**Failure to follow these instructions can result in moderate injury.**

### Backfeed protection

## DANGER

### RISK OF VOLTAGE BACKFEED

In systems where Backfeed protection is not part of the standard design, an automatic isolation device (Backfeed protection option or other device meeting the requirements of IEC 62040-1 or IS 16242, (Part 1)) must be installed to prevent hazardous voltage or energy at the input terminals of the isolation device. The device must open within 15 seconds after the upstream power supply fails and must be rated according to the specifications.

**Failure to follow this instruction will result in death or serious injury.**

When the UPS input is connected through external isolators that when opened isolates neutral, below label must be placed at UPS input terminals.

## DANGER

### RISK OF VOLTAGE BACKFEED

- There is no standard Backfeed protection inside the UPS. Isolate UPS from AC supplies.
- Check for Hazardous Voltage between all terminals including the protective earth before working on the UPS.

**Failure to follow this instruction will result in death or serious injury.**

- Be sure to isolate the UPS before working on it.
- UPS do not have an inbuilt standard backfeed protection. During installation an additional external isolation device must be installed in UPS system.

- External backfeed protection device connections should be done as per the wiring diagram below.

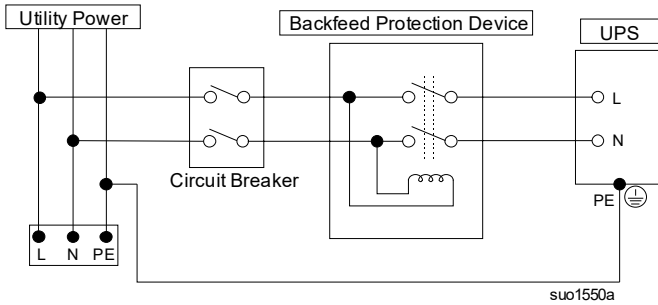



- Use external backfeed protection device as per the table below.

Model	Coil voltage*	Contactors
SRV5KRI/SRV6KRI/SRV6KI	230 VAC	LC1D38P7
SRV10KRI/SRV10KI	230 VAC	LC1D65AP7

\* The appropriate contactor should be sourced based upon the on-site voltage.

- Use conductors for wiring as per the table below.

Model	Wire function	Recommended input and output wire size	Tightening torque
SRV5KRI/ SRV6KRI/ SRV6KI	L, N, 	10 AWG (6 mm <sup>2</sup> ) 105 °C type	17.70 lbf-in (2 N-m)
SRV10KRI/ SRV10KI	L, N, 	8 AWG (10 mm <sup>2</sup> ) 105 °C type	17.70 lbf-in (2 N-m)

### NOTICE

#### RISK OF DAMAGE

Do not use this UPS for Two phase (Line to Line) input configuration. The UPS needs a neutral connection to work properly. Operation without Neutral may damage the unit or connected load.

**Failure to follow these instructions can result in equipment damage.**

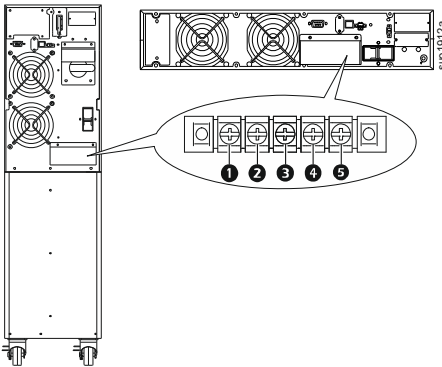

❶	Output terminal - Line
❷	Output terminal - Neutral
❸	Ground terminal/Protective earth
❹	Input terminal - Line
❺	Input terminal - Neutral

#### NOTE:

**SRV5KRI, SRV6KRI, and SRV6KI:** Use 10 AWG (6 mm<sup>2</sup>) 105 °C type wire (not supplied) to hardwire the input/output terminals.

**SRV10KRI, and SRV10KI:** Use 8 AWG (10 mm<sup>2</sup>) 105 °C type wire (not supplied) to hardwire the input/output terminals.

Use insulated ring type lug (not supplied) suitable for M5 screw to connect the wire to the input/output terminals.

1. Locate the hardwire terminal block cover on the rear panel of UPS. Remove the screws securing the cover and remove the cover.
2. Connect the line and neutral wires of the equipment to the output terminals in the terminal block.
3. Connect the line and neutral wires from the utility power to the input terminals in the terminal block.
4. Connect the protective earth/ground wire from the utility power to the ground terminal of unit on the back panel.
5. Replace and secure the cover removed in *step 1*.



# Connect the Battery Pack

**NOTE:** Applicable for SRV5KRI/SRV6KRI/SRV10KRI.

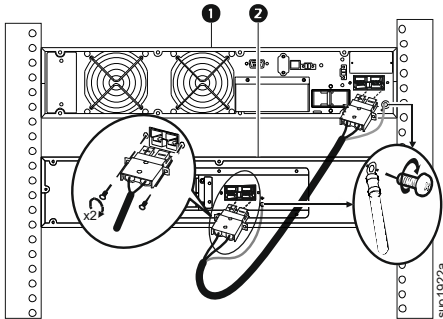

1	Easy UPS
2	Battery Pack

1. Locate the battery connector cover on rear panel of UPS and battery pack.
2. Remove the screws securing the cover and remove the cover.
3. Connect the ground wire to the ground terminal in the UPS and battery pack.
4. Plug one end of the battery cable (supplied) connector into the battery connector receptacle on the rear side of the UPS and the other end of the battery cable connector into the battery connector receptacle on the rear side of the battery pack.
5. Secure the battery connectors to the battery connector receptacles on both the UPS and the battery pack by fastening the screws removed in *step 2*.

# Connect Battery

**NOTE:** Applicable for SRV6KI and SRV10KI

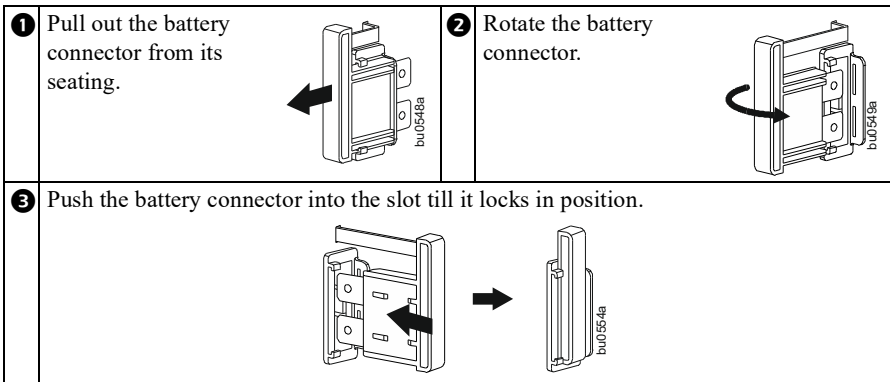

# Start Up

## Connect equipment and input power to the UPS

### CAUTION

#### RISK OF ELECTRIC SHOCK

- All electrical work must be performed by a qualified electrician.
- Turn off all power to this equipment before working on the equipment.
- Practice lockout/tagout procedures
- Do not wear jewelry when working with electrical equipment.

**Failure to follow these instructions can result in moderate injury.**

#### SRV5KRI/SRV6KRI/SRV10KRI models:

1. Connect equipment to UPS. Refer “Hardwiring” on page 14 for details.
2. Connect battery pack to UPS. Refer “Connect the Battery Pack” on page 17 for details.
3. Connect input utility power to the UPS. Refer “Hardwiring” on page 14 for details.
4. Turn on the circuit breaker of the battery pack.

#### SRV6KI/SRV10KI models:

1. Connect equipment to UPS. Refer “Hardwiring” on page 14 for details.
2. Connect battery. Refer “Connect Battery” on page 17 for details.
3. Connect input utility power to the UPS. Refer “Hardwiring” on page 14 for details.
4. Secure the UPS to the ground with the two locking brackets (supplied), after all the hardwiring has been completed.

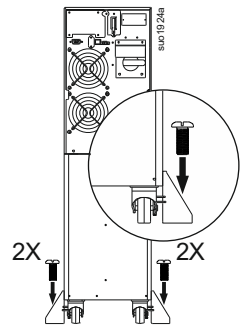

## Start the UPS

Press the POWER ON/OFF button located on the front panel of UPS until a beep is heard. The **Status** LED will illuminate green.

- The battery charges to 90% capacity during the first five hours of normal operation.
- **Do not** expect full backup time during this initial charge period.

## Cold start the UPS

Use cold start feature to supply power to connected equipment from the UPS batteries.

Press the POWER ON/OFF button located on the front panel of UPS until a beep is heard. The front panel display will illuminate.

Press the POWER ON/OFF button again to supply battery power to the connected equipment.

## Turn off the UPS

To turn off the UPS, press and hold the POWER ON/OFF button on the front panel display until a beep is heard.

## Connect and install management software

Easy UPS is provided with SchneiderUPS management software for unattended operating system shutdown, monitoring, control and energy reporting. The following diagram is a representation of a typical server installation.

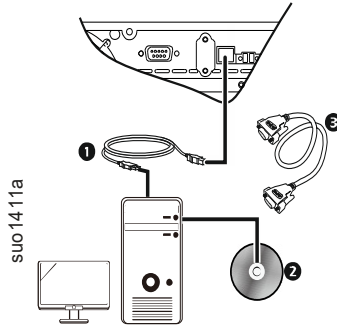

1	Connect the USB cable from the rear of the UPS to the protected device such as a server.
2	For a server or other devices with an operating system, load the SchneiderUPS CD and follow the on-screen set-up instructions.
3	A built-in serial port is also available for additional communication options with serial cable.

Additional communication options are available via the built-in intelligent slot. Visit to APC by Schneider Electric Web site, [www.apc.com](http://www.apc.com) for more information.

# Emergency Power Off

## NOTICE

### RISK OF EQUIPMENT DAMAGE

- Do not connect the EPO interface to any circuit other than an unused circuit.
- Adhere to all national and local electrical codes.
- Wiring must be performed by a qualified electrician.

### Failure to follow these instructions can result in equipment damage.

The Emergency Power Off (EPO) function is a feature that will immediately remove power to all connected equipment.

The EPO switch is internally powered by the UPS for use with non-powered switches or potential free normally closed (N/C) contacts.

### Connecting normally closed (N/C) contacts

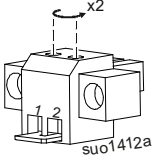
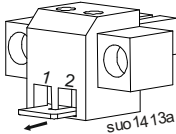
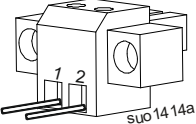
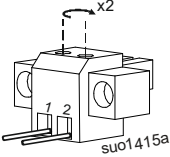
<p><b>1</b> Loosen the screws of terminal 1 and 2 in the EPO connector.</p> 	<p><b>2</b> Remove the metal link between terminals 1 and 2.</p> 
<p><b>3</b> Connect N/C relay contacts between terminals 1 and 2 of the EPO terminal block. Use 0.5 to 1 mm<sup>2</sup> wire.</p> 	<p><b>4</b> Secure the EPO connector screws of terminals 1 and 2.</p> 

**NOTE:** If the N/C contact is open, the UPS will turn off. Power to the connected equipment will be immediately turned off.

**The EPO interface is a Safety Extra Low Voltage (SELV) circuit. Connect it only to other SELV circuits. The EPO interface monitors circuits that have no determined voltage potential. Such closure circuits may be provided by a switch or relay properly isolated from the utility. To avoid damage to the UPS, do not connect the EPO interface to any circuit other than an unused circuit.**

Use one of the following cable types to connect the UPS to the EPO switch.

- CL2: Class 2 cable for general use.
- CL2P: Plenum cable for use in ducts, plenums, and other spaces used for environmental air.
- CL2R: Riser cable for use in a vertical run in a floor-to-floor shaft.

# Maintenance Bypass

Maintenance bypass enables the user to isolate the electronic circuitry of the UPS from the mains and the load without interrupting the load operation by connecting the loads directly to the bypass utility supply.

- This feature is useful while performing maintenance or service and shall only be executed by authorized Technical Service Personnel.
- In case of any mains interruption occurs during Maintenance Bypass operation, all loads on the output will be deenergized. Maintenance Bypass Operation should not be preferred for long time use.

# Operation

## Front panel display features



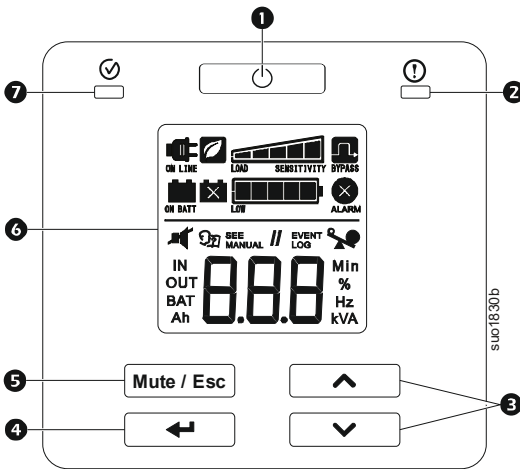





The UPS models are equipped with an intuitive and configurable LCD display. The display complements the software interface as both convey similar information and either may be used to configure the UPS settings.





1	<b>POWER ON/OFF button</b>	<ul style="list-style-type: none"> <li>• Press the POWER ON/OFF button to turn the UPS on.</li> <li>• Press and hold the POWER ON/OFF button until a beep is heard to turn off the UPS.</li> <li>• Press the POWER ON/OFF button to reset alerts.</li> </ul>
2	<b>Alert LED</b>	The <b>Alert</b> LED illuminates red when the UPS detects an internal error and flashes red for UPS notifications. Refer “Alerts and Notifications” on page 27 for details.
3	<b>UP/DOWN ARROW button</b>	Press the UP/DOWN ARROW button to scroll through the main menu options and display screens.
4	<b>ENTER button</b>	Press the ENTER button to enter the menu or to select a menu item/value during navigation.

5	<b>MUTE/ESC button</b>	<p>Press the MUTE/ESC button:</p> <ul style="list-style-type: none"> <li>• To acknowledge audible alerts and suppress them temporarily.</li> <li>• To exit a sub menu and return to the main menu.</li> </ul>
6	<b>LCD Display</b>	<p>The display interface options are visible on this LCD screen. Press the UP/DOWN ARROW button to activate LCD, if the display is not illuminated.</p>
7	<b>Status LED</b>	<p>The <b>Status LED</b> illuminates green when the power is on. The LED indicates two different states of output power:</p> <ul style="list-style-type: none"> <li>• <b>Output off:</b> LED flashes. Press POWER ON/OFF button to turn the output power on.</li> <li>• <b>Output on:</b> LED illuminates green continuously.</li> </ul>

### Front panel display icons

 <b>ON LINE</b>	<p><b>On Line:</b> The UPS is drawing utility power and performing double conversion to supply power to the connected equipment.</p>
 <b>ON BATT</b>	<p><b>On Battery:</b> The UPS is supplying battery backup power to the connected equipment.</p>
	<p><b>Replace Battery:</b> The battery is not connected securely or the battery is nearing the end of its service life and should be replaced.</p>
 <b>BYPASS</b>	<p><b>Bypass:</b> The UPS is in bypass mode, sending utility power directly to connected equipment. Bypass mode operation is the result of an internal UPS event, an overload condition. Refer “Advanced Display Navigation” on page 26 for details. Illumination of this icon and Green Mode icon indicates that the UPS is in Green Mode Operation.</p>
 <b>ALARM</b>	<p><b>System Alerts:</b> The UPS has detected an internal error. Refer “Alerts and Notifications” on page 27 for more details.</p>
	<p><b>Overload:</b> The equipment connected to the UPS is drawing more power than rated.</p>
	<p><b>Battery Charge:</b> The battery charge level is indicated by the number of bar sections illuminated. When all five blocks are illuminated, the battery is fully charged. Each bar represents approximately 20% of the battery charge capacity.</p>
	<p><b>Load Level:</b> The load percentage is indicated by the number of load bar sections illuminated. Each bar represents approximately 20% of the maximum load capacity.</p>
	<p><b>Mute:</b> An illuminated line through the icon indicates that the audible alert is disabled.</p>

	<p><b>Green Mode:</b> An illuminated icon indicates that the unit is working in Green mode. The connected equipment is receiving the utility input directly as long as the input voltage and frequency are within the configured limits.</p>
	<p><b>Alert or notification:</b> The UPS has detected an internal error or the UPS is in configuration mode. Refer “Alerts and Notifications” on page 27 for details.</p>
	<p><b>Event:</b> The icon is illuminated when the user is viewing the event log.</p>

## Status Indicators

Audible Alert	Condition
One beep every second	<p><b>Low Battery State:</b> The battery is nearing its discharge state. The UPS is about to shutdown.</p>
	<p><b>Overload condition:</b> The equipment connected to the UPS is drawing more power than rated.</p>
4 beeps every 30 sec (first beep starts after 4 sec on battery)	<p><b>On Battery State:</b> The UPS is supplying battery backup power to the connected equipment.</p>
Continuous beeps	<p><b>Alert State:</b> UPS has detected an internal error. Refer “Alerts and Notifications” on page 27 for details.</p>
Two short beeps every 5 sec	<p><b>Event Bypass State:</b> UPS has detected an internal error. Connected equipment receives utility power through the bypass relay.</p>

# UPS Display Parameters

Operational data displayed in the front panel display is given in the table. Navigate using the UP/DOWN ARROW buttons.

Parameter	Units	Indicator Icons
Output voltage	Vac	OUT, V
Output frequency	Hz	OUT, Hz
Input voltage	Vac	IN, V
Input frequency	Hz	IN, Hz
Battery voltage	VDC	BAT, V
Charging current	A	BAT, A
Ambient temperature	°C	NUMBER, C
State of battery charge	%	BAT, %
Load level in percentage (Maximum of Watts or VA)	%	OUT, %
Load level in kVA	kVA	OUT, kVA
Total Ah capacity of connected battery	Ah	BAT, Ah
Remaining On Battery runtime	Minutes	BAT, Min
Ah capacity of connected battery	Ah	BAT, Ah

## Configuration

### Configure UPS parameters

Follow the steps to configure parameters in the UPS:

1. Press the ENTER button.
2. Press the UP/DOWN ARROW buttons to navigate to “Set”.
3. Press the ENTER button.
4. Navigate through the parameters using the UP/DOWN ARROW buttons.
5. Press the ENTER button to edit a parameter. Icons start flashing to indicate the editing.
6. Press the UP/DOWN ARROW buttons to navigate between the options available for the selected parameter.
7. Press the ENTER button to select the option or MUTE/ESC button to abort the editing of current parameter. Flashing of icons stops after this.
8. Press the UP/DOWN ARROW buttons to navigate between parameters.
9. Press the MUTE/ESC button to exit menu navigation.



## UPS settings

Configure UPS settings using the display interface. Refer “Configure UPS parameters” on page 24 to edit the parameters.

Function	Factory Default	User Selectable Options	Description
<b>Output voltage</b>	230 VAC	<ul style="list-style-type: none"> <li>• 220 VAC</li> <li>• 230 VAC</li> <li>• 240 VAC</li> </ul>	Allows the user to select output voltage while the UPS is in standby mode.
<b>Audible alert</b>	Enabled	<ul style="list-style-type: none"> <li>• Enable</li> <li>• Disable</li> </ul>	Allows the user to mute the audible alerts of the UPS when set to disable or when the MUTE button is pressed.
<b>Green mode / high efficiency mode</b>	Disabled	<ul style="list-style-type: none"> <li>• Enable</li> <li>• Disable</li> </ul>	When this mode is enabled, connected equipment receives utility input power through the bypass relay as long as input voltage is within the range of $\pm 5\%$ of configured output voltage and $\pm 4$ Hz of configured output frequency. Inverter is turned off during this mode. If utility power input goes out of range, inverter is turned on. The load is transferred to on-line mode. The power to the connected equipment may be interrupted up to 10 milliseconds.
<b>Battery Ah capacity</b>	<b>SRV5KRI/SRV6KRI:</b> 7 Ah <b>SRV10KRI:</b> 9 Ah		Factory setting; not settable by user.
<b>Charger current</b>	1 A		Factory setting; not settable by user.
<b>Output voltage adjustment</b>	230 VAC	<ul style="list-style-type: none"> <li>• <math>220 \pm 0\sim 9</math> V</li> <li>• <math>230 \pm 0\sim 9</math> V</li> <li>• <math>240 \pm 0\sim 9</math> V</li> </ul>	Allows the user to adjust the output voltage by using the UP/DOWN ARROW button. This parameter can be set either in line mode or battery mode.
<b>Inverter voltage adjustment</b>	Add 0	<ul style="list-style-type: none"> <li>• Add 000 ~ 09.9 V</li> <li>• Sub 000 ~ 09.9 V</li> </ul>	Allows the user to adjust the inverter voltage by choosing Add or Sub. The voltage range is from 0 V to 9.9 V. The default value is 0 V. This parameter can be set either in line mode or battery mode.

# Advanced Display Navigation

The UPS display has five menu options. Press the ENTER button from the Home Screen to access these menu options. Use the UP/DOWN ARROW buttons to navigate between the menu options.

Menu option	Description
SEt	<p><b>Configure the UPS</b>            Use this menu option to configure the UPS parameters.            Press the ENTER button to view the configuration options.            Refer “Configure UPS parameters” on page 24 for details.            Press the MUTE/ESC button to return to the Home Screen.</p>
LOG	<p><b>Show Event Log</b>            Use this menu option to view the UPS event log. The UPS records the last 10 events and displays the codes in this log.            Press the ENTER button to view the log. Use the UP/DOWN ARROW buttons to view the logged events. The DOWN ARROW button navigates towards old events and the UP ARROW button navigates to new events.            Every log entry has a numeric and textual event code.            At the end of the log, the word “End” will be displayed.            Press the MUTE/ESC button to return to the Home Screen.</p>
UPS	<p><b>Show UPS information</b>            Use this menu option to view the UPS information.            Press the ENTER button to view the rating of the UPS.            Press the UP ARROW button to view the UPS firmware version.            Press the MUTE/ESC button to return to the Home Screen.</p>
bYP	<p><b>User Command to bypass</b>            Use this menu option to switch the UPS to bypass mode or bring the UPS to on-line mode from bypass mode.            Press ENTER button:</p> <p style="margin-left: 40px;">Put      <b>Put:</b> Use to switch the UPS to bypass mode of operation.  <b>NOTE:</b> Power to the connected equipment will drop, if the mains voltage is not within the threshold limits.</p> <p style="margin-left: 40px;">Out      <b>Out:</b> Bring the UPS out of bypass and restore clean power to the connected equipment.</p>

Menu option	Description
<p>EST</p> <p><b>Execute Battery Self Test</b>            Use this menu option to conduct a self test and determine the battery status. Press the ENTER button to initiate the test.            If the test command is accepted, the UPS will initiate a self test and will start a count down on the display.            Display messages are shown at the end of the test.</p> <p>rFd      Test refused. The output is off or battery is not charged.</p> <p>FLd      Test not passed.</p> <p>PAS      Test passed.</p> <p>Press the MUTE/ESC button to return to the Home Screen.</p>	

## Alerts and Notifications

UPS displays a text code and a numeric code on the display when it detects an internal error.

### Alerts

Display code	Description	Solution
SC	UPS has experienced a short circuit at the output. Unit will try to auto-recover from this condition.	Be sure that there is no short circuit at the UPS output. Remove the short circuit and wait for the UPS to auto-recover or press POWER ON/OFF button to start the UPS. <b>NOTE:</b> The connected equipment will not receive power from the UPS under this condition.
OL	UPS is experiencing an overload condition.	Disconnect nonessential equipment from the UPS to eliminate the overload condition.
dCH	The UPS has detected a DC voltage error. Unit will try to auto-recover from this condition.	If the UPS does not recover automatically, contact APC by Schneider Electric.
HOT	Temperature of the unit is rising above the set limits.	Disconnect nonessential equipment from the UPS to reduce the load. Ensure that ambient temperature is within limits. Ensure that adequate clearance is maintained.
CH9	UPS has detected a charger error.	Be sure that there no short circuit at the UPS battery terminals. Press POWER ON/OFF button to start the UPS.

Contact APC by Schneider Electric for all other alert codes.

## Notifications

Display code	Description	Solution
bdc	Battery is not connected.	Connect battery to the UPS. <b>SRV5KRI/SRV6KRI/SRV10KRI:</b> Refer “Connect the Battery Pack” on page 17 for details. <b>SRV6KI/SRV10KI:</b> Refer “Connect Battery” on page 17 for details.
EPO	EPO enabled.	Set the circuit in closed position to disable EPO function.

## Troubleshooting

Use the table below to solve minor installation and operation problems. Refer to the APC by Schneider Electric Web site, [www.apc.com](http://www.apc.com) for assistance with complex UPS problems.

Problem and/or Possible Cause	Solution
<b>UPS will not turn on when utility input is available or there is no power output.</b>	
The UPS is not turned on.	Press the POWER button to turn on the UPS.
The UPS is not connected to utility power supply.	Be sure that the power cable from the UPS to the utility power supply is securely connected at both ends.
Input thermal circuit breaker on the UPS is tripped.	Press the input thermal circuit breaker Turn on the circuit breaker in the rear panel. Refer “Rear Panel Features” on page 9 for details.
<b>The UPS is operating on battery, while connected to the input utility power</b>	
There is high, low, or distorted input voltage or frequency.	Connect the UPS to a different outlet on a different circuit. Test the utility input power to ensure the unit is receiving input power. If display is on, navigate and check the input voltage and frequency.
<b>UPS, when connected to battery, is not supplying power to the connected equipment</b>	
The UPS is not turned on.	If the UPS has shutdown (the display is not on), turn the UPS on by following the Cold start procedure. Refer “Cold start the UPS” on page 19 for details.
The battery is not connected.	Connect battery to the UPS. <b>SRV5KRI/SRV6KRI/SRV10KRI:</b> Refer “Connect the Battery Pack” on page 17 for details. <b>SRV6KI/SRV10KI:</b> Refer “Connect Battery” on page 17 for details.
Low battery cut off. UPS may have discharged the battery due to utility power outage and turned the output off due to low battery condition.	Wait for the utility power to be restored and charge the battery. Press the POWER ON/OFF button to turn on the UPS after the utility power is restored.

<b>Problem and/or Possible Cause</b>	<b>Solution</b>
<b>UPS emits an audible beeping sound at long intervals</b>	
The UPS is operating normally when running on battery.	UPS has detected an internal error. Refer “Alerts and Notifications” on page 27 for details.
<b>Alert LED is illuminated. The UPS displays an alert message and emits a constant beeping sound</b>	
The UPS has detected an internal error.	Refer “Alerts and Notifications” on page 27 for details.
<b>No audible sounds from UPS even when the Alert LED is illuminated</b>	
Audible alert is disabled.	Change the UPS configuration to enable audible alerts.
<b>UPS is not providing expected backup time</b>	
The UPS battery is discharged due to a recent power outage.	The batteries require recharging after extended outages. Battery life gets impacted when put into service without being fully recharged or when operated at elevated temperatures.
The battery is near the end of its service life.	If the battery is near the end of its service life, consider replacing the battery, even if the replace battery indicator is not illuminated.
<b>UPS is not turning off</b>	
POWER ON/OFF button not pressed for sufficient time.	Press and hold the POWER ON/OFF button until a beep is heard.
Utility input power is available.	UPS logic power cannot be turned off if utility input power is available. To turn off the UPS, turn off utility input power and press POWER ON/OFF button. Release the button when a beep is heard.
<b>UPS is in Bypass mode and the LED is not illuminated red</b>	
UPS is in green mode.	Disable green mode if it is not desired.
UPS is configured to stay in the bypass mode.	Change the configuration to exit bypass mode.
<b>UPS is in Bypass mode and the LED is illuminated red</b>	
UPS is in bypass mode even after over temperature alarm is cleared.	Reduce the connected load to < 70% to bring the UPS to on-line mode.
The UPS has experienced an overload condition and transferred to bypass.	Connected equipment exceeds the maximum load as defined in specifications. The alerts remain on until the overload condition is corrected. Disconnect nonessential equipment from the UPS to eliminate the overload condition. The UPS continues to supply power as long as it is in bypass mode and the circuit breaker does not trip. The UPS will not provide battery power in the event of a utility power interruption.
UPS detected an internal error and transferred to bypass.	Refer “Alerts and Notifications” on page 27 for details.

# Transport

1. Shut down and disconnect all connected equipment.
2. Disconnect the unit from mains power.
3. Disconnect all internal and external batteries if connected.
4. Follow the shipping instructions outlined in the *Service* section of this manual.

# Service

If the unit requires service, do not return it to the dealer. Follow these steps:

1. Review the *Troubleshooting* section of the manual to eliminate common problems.
2. If the problem persists, contact APC by Schneider Electric Customer Support.
  - a. Note the model number and serial number and the date of purchase. The model and serial numbers are located on a label in the rear panel of the unit and are also available through the LCD display on select models.
  - b. Call APC by Schneider Electric Customer Support and a technician will attempt to solve the problem over the phone. If this is not possible, the technician will issue a Return Material Authorization Number (RMA#).
  - c. If the unit is under warranty, the repairs are free.
  - d. Service procedures and returns may vary internationally. For country specific instructions refer to the APC by Schneider Electric website, [www.apc.com](http://www.apc.com).
3. Pack the unit properly to avoid damage in transit. Never use foam beads for packaging.

Damage sustained in transit is not covered under warranty.

**NOTE:** Before shipping, always disconnect battery modules in the UPS or external battery pack.

The disconnected internal batteries may remain inside the UPS or external battery pack.
4. Write the RMA# provided by Customer Support on the outside of the package.
5. Return the unit by insured, prepaid carrier to the address provided by Customer Support.

# Limited Factory Warranty

Schneider Electric IT Corporation (SEIT), warrants its products to be free from defects in materials and workmanship for a period of two (2) years from the date of purchase. The SEIT obligation under this warranty is limited to repairing or replacing, at its own sole option, any such defective products or parts thereof. Repair or replacement of a defective product or part thereof does not extend the original warranty period.

This warranty applies only to the original purchaser who must have properly registered the product within 10 days of purchase. Products may be registered online at [warranty.apc.com](http://warranty.apc.com).

SEIT shall not be liable under the warranty if its testing and examination disclose that the alleged defect in the product does not exist or was caused by end user or any third person misuse, negligence, improper installation, testing, operation or use of the product contrary to SEIT recommendations or specifications. Further, SEIT shall not be liable for defects resulting from: 1) unauthorized attempts to repair or modify the product, 2) incorrect or inadequate electrical voltage or connection, 3) inappropriate on-site operation conditions, 4) Acts of God, 5) exposure to the elements, or 6) theft. In no event shall SEIT have any liability under this warranty for any product where the serial number has been altered, defaced, or removed.

**EXCEPT AS SET FORTH ABOVE, THERE ARE NO WARRANTIES, EXPRESS OR IMPLIED, BY OPERATION OF LAW OR OTHERWISE, APPLICABLE TO PRODUCTS SOLD, SERVICED OR FURNISHED UNDER THIS AGREEMENT OR IN CONNECTION HERewith.**

**SEIT DISCLAIMS ALL IMPLIED WARRANTIES OF MERCHANTABILITY, SATISFACTION AND FITNESS FOR A PARTICULAR PURPOSE.**

**SEIT EXPRESS WARRANTIES WILL NOT BE ENLARGED, DIMINISHED, OR AFFECTED BY AND NO OBLIGATION OR LIABILITY WILL ARISE OUT OF, SEIT RENDERING OF TECHNICAL OR OTHER ADVICE OR SERVICE IN CONNECTION WITH THE PRODUCTS.**

**THE FOREGOING WARRANTIES AND REMEDIES ARE EXCLUSIVE AND IN LIEU OF ALL OTHER WARRANTIES AND REMEDIES. THE WARRANTIES SET FORTH ABOVE CONSTITUTE SEIT'S SOLE LIABILITY AND PURCHASER'S EXCLUSIVE REMEDY FOR ANY BREACH OF SUCH WARRANTIES. SEIT WARRANTIES EXTEND ONLY TO ORIGINAL PURCHASER AND ARE NOT EXTENDED TO ANY THIRD PARTIES.**

**IN NO EVENT SHALL SEIT, ITS OFFICERS, DIRECTORS, AFFILIATES OR EMPLOYEES BE LIABLE FOR ANY FORM OF INDIRECT, SPECIAL, CONSEQUENTIAL OR PUNITIVE DAMAGES, ARISING OUT OF THE USE, SERVICE OR INSTALLATION OF THE PRODUCTS, WHETHER SUCH DAMAGES ARISE IN CONTRACT OR TORT, IRRESPECTIVE OF FAULT, NEGLIGENCE OR STRICT LIABILITY OR WHETHER SEIT HAS**

**BEEEN ADVISED IN ADVANCE OF THE POSSIBILITY OF SUCH DAMAGES. SPECIFICALLY, SEIT IS NOT LIABLE FOR ANY COSTS, SUCH AS LOST PROFITS OR REVENUE, WHETHER DIRECT OR INDIRECT, LOSS OF EQUIPMENT, LOSS OF USE OF EQUIPMENT, LOSS OF SOFTWARE, LOSS OF DATA, COSTS OF SUBSTITUANTS, CLAIMS BY THIRD PARTIES, OR OTHERWISE.**

**NOTHING IN THIS LIMITED WARRANTY SHALL SEEK TO EXCLUDE OR LIMIT SEIT LIABILITY FOR DEATH OR PERSONAL INJURY RESULTING FROM ITS NEGLIGENCE OR ITS FRAUDULENT MISREPRESENTATION OF TO THE EXTENT THAT IT CANNOT BE EXCLUDED OR LIMITED BY APPLICABLE LAW.**

To obtain service under warranty you must obtain a Returned Material Authorization (RMA). Customers with warranty claims issues may access the SEIT worldwide customer support network through the SEIT Web site: **www.apc.com**. Select your country from the country selection drop down menu. Open the Support tab at the top of the web page to obtain information for customer support in your region. Products must be returned with transportation charges prepaid and must be accompanied by a brief description of the problem encountered and proof of date and place of purchase.

## **APC by Schneider Electric Worldwide Customer Support**

Customer support for this or any other APC by Schneider Electric product is available at no charge in any of the following ways:

- Visit the APC by Schneider Electric website to access documents in the APC by Schneider Electric Knowledge Base and to submit customer support requests.
  - [www.apc.com](http://www.apc.com) (Corporate Headquarters)  
Connect to localized APC by Schneider Electric websites for specific countries, each of which provides customer support information.
  - [www.apc.com/support/](http://www.apc.com/support/)  
Global support searching APC by Schneider Electric Knowledge Base and using e-support.
- Contact the APC by Schneider Electric Customer Support Center by telephone or e-mail.
  - Local, country specific centers: go to [www.apc.com/support/contact](http://www.apc.com/support/contact) for contact information.

For information on how to obtain local customer support, contact the APC by Schneider Electric representative or other distributor from whom you purchased your APC by Schneider Electric product.